



STs Series™ Device Manual



CONTENTS

- 1.0 Introduction 3
- 1.1 Product Description..... 3
- 1.2 System Terminology 5
- 2.0 Sensor Preparation..... 6
- 2.1 Unpacking and Inspection 6
- 2.2 Preparing the Sensor for Use 6
- 2.3 Assembly or Disassembly of the Sensor 7
 - 2.3.1 Installation or Removal of Electrode 7
 - 2.3.2 Installation or Removal of Cable Assembly 9
 - 2.3.3 Installation or Removal of Transmitter Circuit Board 9
- 3.0 Conductivity 11
- 3.1 Conductivity Calibration 11
- 3.2 Conductivity Care and Maintenance 13
- 3.3 Conductivity Storage 14
- 3.4 Conductivity Specifications 14
- 4.0 Dissolved Oxygen 16
- 4.1 Dissolved Oxygen Calibration 16
- 4.2 Dissolved Oxygen Care and Maintenance 18
- 4.4 Dissolved Oxygen Storage 19
- 4.5 Dissolved Oxygen Specifications..... 20
- 5.0 ORP 21
- 5.1 ORP Calibration 21
- 5.2 ORP Care and Maintenance 23
- 5.3 ORP Storage..... 23
- 5.4 ORP Specifications 23
- 6.0 pH 24

6.1	pH Calibration.....	24
6.2	pH Care and Maintenance.....	25
6.3	pH Special Considerations	26
6.5	pH Specifications	26
7.0	Temperature	27
7.1	Temperature Calibration	27
7.2	Temperature Care	28
7.3	Temperature Special Considerations.....	28
7.4	Temperature Specifications.....	28
8.0	Mounting of the Sensor.....	29
9.0	Warranty	30
10.0	Return of Material.....	31
11.0	Proper Disposal At End of Life	31

1.0 INTRODUCTION

1.1 PRODUCT DESCRIPTION

Thank you purchasing a pHionics STs Series sensor. The product will provide years of service if it is maintained according to the guidelines suggested in these instructions.

The STs series of submersible water quality sensors have an integrated preamp and an isolated two-wire 4-20 ma transmitter. Two independent channels simultaneously transmit a water quality parameter (pH, conductivity, dissolved oxygen, ORP) and a temperature signal -- two wires for pH and two wires for temperature. The compact design afforded by the patented pHiConn™ keyless connection system – along with 316SS (titanium optional) and Delrin or PVDF construction -- make this rugged device ideal for environmental water quality applications. Individual units can be combined to make redundant or multiparameter modules using the pHionics' patented pHiKlip™ array system. As with all pHionics' designs, the sensors are designed to simplify water quality measurement so you can focus on what matters most to you.

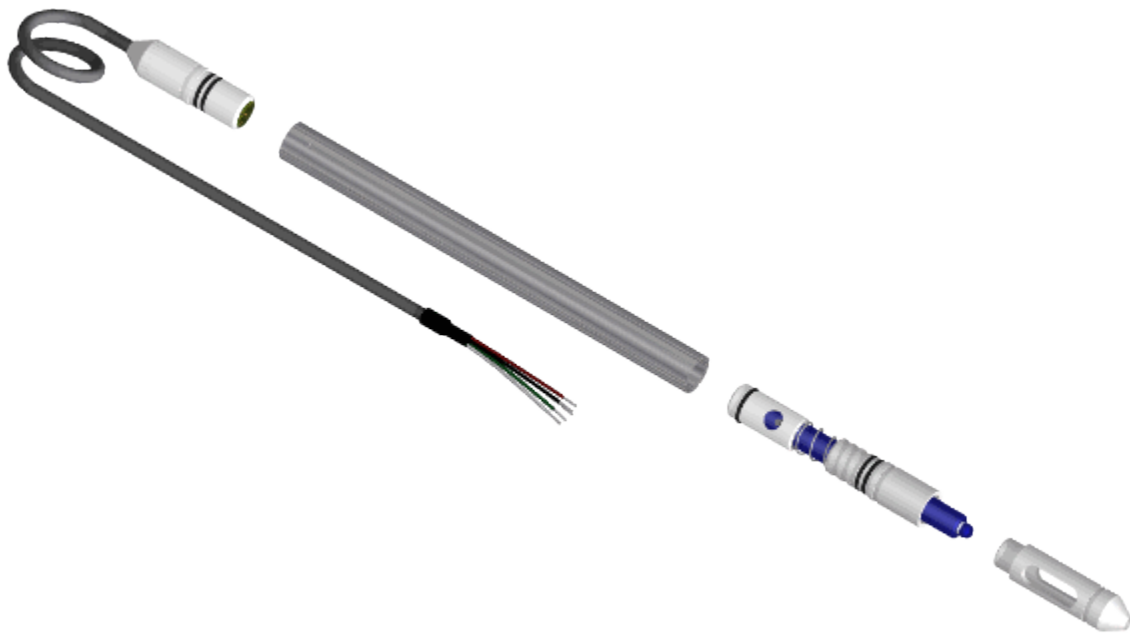

The 'true 2-wire' (no confusing third wire for power), 4-20 ma STs series sensor send a current proportional to the parameter being measured on the same two wires that provide the power (8 to 40 volts dc). Current transmission allows for long runs of inexpensive cable or wire (up to three miles with proper gauge of wire) that is virtually noise-free without any signal loss that is common to voltage (IR drop) or digital (capacitance or reactance affecting 'rise/fall' timing). The low, eight-volt minimum operation voltage allows the units to be powered by 12-volt battery systems with 4 volts of compliance, making them compatible with RTU's and solar powered applications. The units are intended for calibration via software supplied with the datalogger or connected receiver.

The pH, dissolved oxygen, or conductivity signal on Channel 1 is automatically temperature compensated to standardize outputs and save you time. This is not to be confused with the temperature channel of the sensor, which provides an independent, isolated, 4-20 ma output proportional to the 0 to 50 °C range on Channel 2.

Wiring Diagram

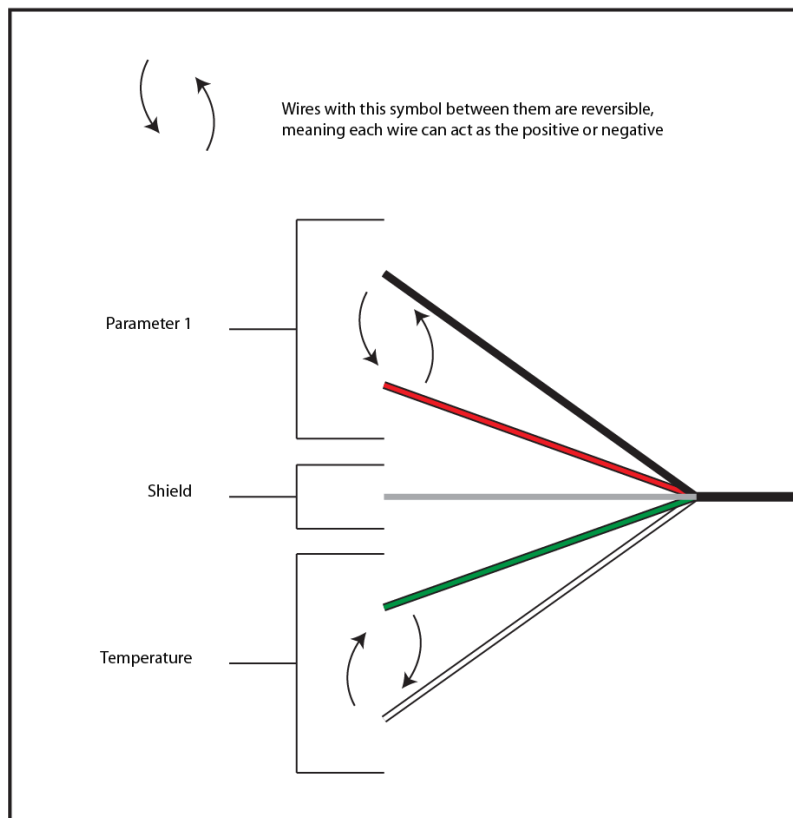

The auto-polarity correction feature directs the applied supply voltage to allow for proper operation regardless of wire hookup. The **RED** and **BLACK** wires are for channel 1 -- pH, and the **WHITE** and **GREEN** wires are for channel 2 -- temperature. The electrode can be replaced in 15 seconds -- further reducing costs.

1.2 SYSTEM TERMINOLOGY

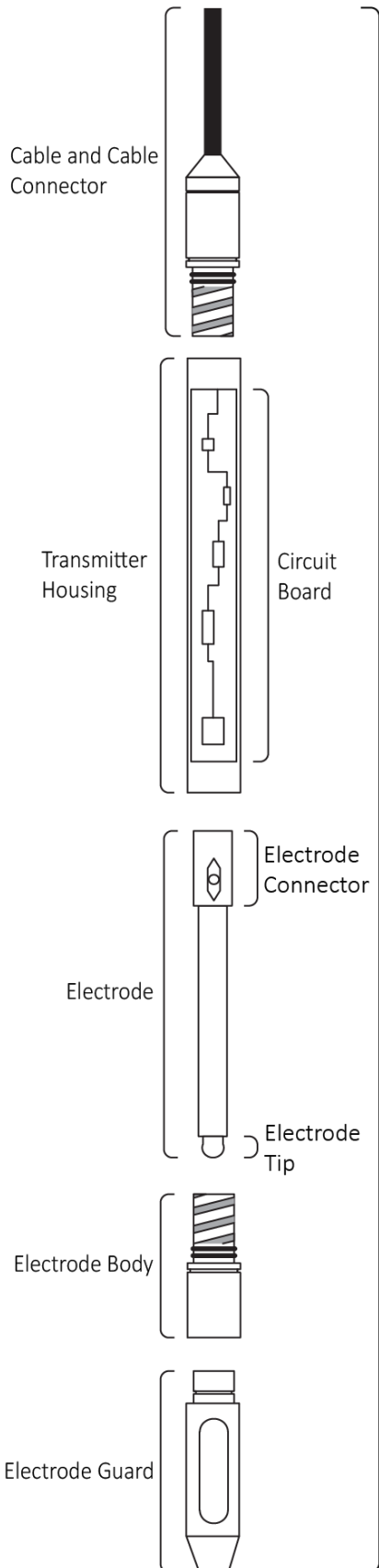

- **Jacketed Cable and Connector** – Kevlar™ (DuPont) reinforced, shielded, water-blocked, polyurethane jacketed cable built for tough applications that screws into the transmitter housing.
- **Transmitter Housing** – 316 Stainless Steel or titanium designed for long-term submersion. Protects the **circuit board** from impact and acts as solution ground and a shield to improve output accuracy.
- **Circuit board** – The brain of the device protected inside the transmitter housing that differentiates noise and amplifies the signal.
- **Electrode** – The sensing device. The **electrode connector** contacts the **circuit board**.
- **Electrode Tip** – The potentiometric sensing element of the **electrode**. Conductivity electrodes measure with cells present along the length of electrode instead of the tip.
- **Electrode body** – Fits over the outside of the **electrode**. It threads into the **transmitter housing** and provides a strong waterproof seal.
- **Electrode guard** – Protective plastic placed over the electrode tip to prevent damage and reduce debris build-up. Removable for easy maintenance.

All parts are replaceable and can be purchased at phionics.com.

2.0 SENSOR/TRANSMITTER PREPARATION

2.1 UNPACKING AND INSPECTION

- Confirm that all parts appear have sustained no detectable damage in shipment.
- Save the packing carton, vinyl boots, and packing materials in case the sensor needs to be returned to the factory for credit or repair.

2.2 PREPARING THE SENSOR FOR USE

The system is typically shipped ready to use after removal of the protective boots and attachment of the cable assembly.

- The vinyl boot (usually **BLACK** or **GREY** in color) covering the electrode should remain on until the unit is to be calibrated or applied to the application of interest.
- Remove the vinyl boot from the cable assembly. Inspect the gold rings of the connector to verify that they are free of dirt or contaminants that may interfere with an electrical connection. Inspect the external O-rings on the cable assembly – verify that they also are free of dirt or particulate that could preclude a proper seal when attached to the sensor.
- Remove the vinyl boot from the cable end of the sensor (the end with the logo). Inspect the cable end of the unit to verify that the housing has not been damaged on the connector end.
- Insert the cable assembly into the housing until a resistance is met. Apply a slight inward pressure and turn the sensor clockwise to thread the connector into the transmitter housing. Do not turn the cable as this could result in cable or seal damage. Continue to turn the housing until the plastic of the cable connector is flush with the housing. Do not overtighten as that may strip the connector thread.
- For calibration, proceed to the appropriate parameter in section 3. If further assembly or disassembly is desired – proceed to section 2.3.

2.3 ASSEMBLY OR DISASSEMBLY OF THE SENSOR

2.3.1 INSTALLATION OR REMOVAL OF ELECTRODE

Every electrode is designed to be very simple to replace to save you time and money. Replacement is required only when the electrode offset is greater than 15% after proper cleaning and calibration. Please view our articles linked below for more information on these topics. A video showing the step-by-step process of electrode replacement is also provided below. If you have any questions or feel that the electrode lasted far less time than expected, please reach out to us using the information on our contact page.

[When to Calibrate and Replace an Electrode](#)

[VIDEO: Electrode Removal and Replacement](#)

Always follow proper safety precautions for chemicals that may remain on the sensor after removal from application e.g. Use gloves when handling the sensor if removed from wastewater containing biohazards.

Always dry off sensor before removing or replacing parts and inspect the interior for any debris that might affect the O-ring seals. A Q-tip or soft cloth may be used to clean the interior if any debris is found.

Always perform removal or replacement of parts in an area where loose parts will not be lost.

Always inspect the connectors (gold concentric circles at ends of the electrode and cable connector) for cleanliness to ensure proper connection.

We recommend cleaning and lubricating the O-rings with silicon grease during any part change.

Required Equipment

1. **New electrode**
2. **pHionics STs Series Sensor**

Recommended Equipment

1. **Safety goggles** — Prevents potassium chloride from getting into eyes if it splashes.
2. **Silicon grease** — Helps with waterproofing and makes installation process easier.

3. **Container** — Used to catch potassium chloride if it spills out of the bottle holding the new electrode (Used for pH and ORP electrodes).
4. **Rubber band** — Helps to grip **electrode body** and **electrode connector** because the O-rings will “set” over time and form a very tight seal that can make removal of certain parts difficult.
5. **Paper towel** — Useful for drying off the sensor.

Procedure

1. Grip electrode body with one hand and transmitter housing with other and twist counterclockwise to unscrew the electrode body.
 - a. The O-rings may have formed a tight seal in the transmitter and made it difficult to twist. This is called “**setting**”. If you are unable to unscrew the electrode body, wrap a rubber band around the for better grip.
2. Grip electrode body in one hand and electrode connector in other to twist and pull the electrode out *slowly*. The glass bulb of pH and ORP sensors could shatter if pulled out in an uncontrolled manner.
 - b. Inner O-rings may have set, making removal difficult. Wrapping a rubber band around electrode connector will help with removal.
3. The electrode is now removed from the electrode body and, if expired, can be disposed of by following all local laws and regulations. If the spring came off with the electrode, reinsert it into the electrode body.

Dissolved oxygen and conductivity electrodes do not come in bottles so steps 5-7 are not relevant for these sensors.

4. Unscrew cap on spare electrode bottle. Electrode should be held in by an O-ring.
5. Grip electrode between cap and bottle and gently pull until O-ring seal *pops* out.
 - a. Be careful to avoid brushing glass bulb against bottle so bulb does not get damaged
6. Push cap off toward bulb to remove cap and O-ring, again being careful not to touch the glass bulb.
7. *Recommended:* Apply silicon grease around top inch of electrode. Avoid getting any grease on glass bulb.
 - a. This makes insertion easier and improves sealing.
8. Insert new electrode into electrode body with spring. Resistance will be met when electrode contacts inner O-rings. Gently push past them and continue pushing until electrode connector touches spring when connector is depressed as shown in the image

below.

Proper Depth of Electrode Connector

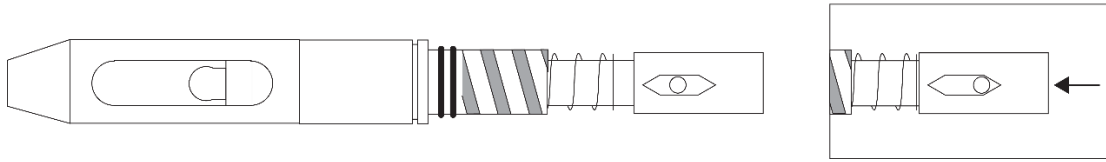

9. Reinsert electrode body into transmitter housing and screw in until plastic is flush with metal body.
10. Do not overtighten as the plastic can be stripped and make removal and replacement of electrode difficult.
11. Calibrate electrode.
12. If readings seem slow, rinse with distilled water and place in 0.1M HCl solution for up to 20 mins. This will remove KCl build-up resulting from storage solution.
13. If readings remain slow or other issues occur, please reach out to us at support@phionics.com so we can help.

Please dispose of each electrode properly by following all local laws and regulations.

2.3.2 INSTALLATION OR REMOVAL OF CABLE ASSEMBLY

Removal of cable assembly

Review all precautions noted at the beginning of this section on page 8.

1. Grip the transmitter housing in one hand and the cable connector in the other.
2. Unscrew transmitter housing from the cable connector, as twisting the cable could cause damage.

Installation of *cable assembly*

1. Insert the cable assembly into the transmitter housing until resistance is met.
2. Push the cable connector into the transmitter housing while twisting the housing (**Not the cable connector**). Continue to twist until the plastic connector is flush with the metal housing. Do not continue tightening as that may result in damage to the connector thread.

2.3.3 INSTALLATION OR REMOVAL OF TRANSMITTER CIRCUIT BOARD

The transmitter circuit board should not usually need to be removed from the housing, however, it can be done easily when required. Removal is best approached by taking off the electrode and cable connector from the housing using the instructions in the previous sections.

Removal of Transmitter Circuit Board

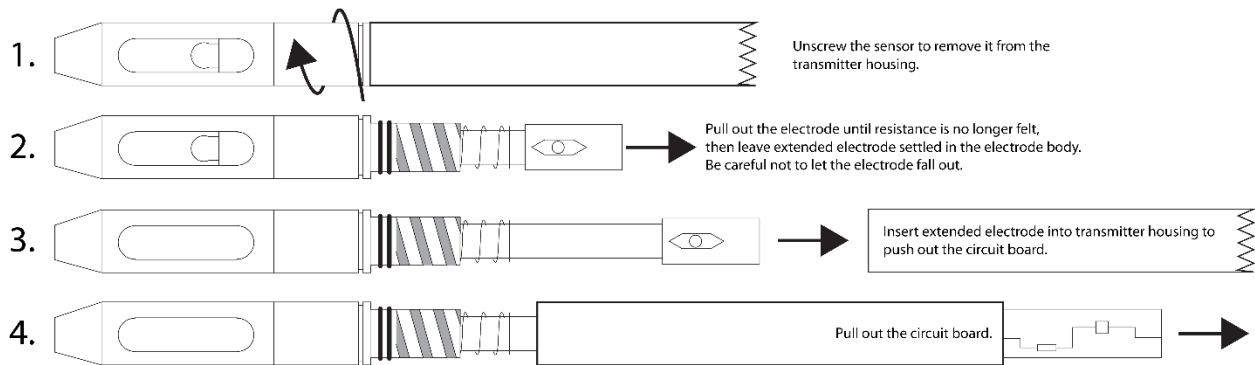

Pay attention to which end was facing the cable to allow for proper alignment when reinserted.

If using a technique other than what is described before, use extreme care, because the elastomeric connectors on the pc boards can be easily damaged by foreign objects or mishandling.

Installation of transmitter

To reinsert the transmitter circuit board, make sure that both the cable connector and electrode are removed.

1. Reinsert the electrode into the electrode to the proper depth and screw in the sensor as described in Section 2.3.1. Reinstall the electrode body into the end opposite the logo and serial number.
2. Insert the smaller end of the transmitter PC board by holding the edges and slide the board into the housing – avoiding the indent on the metal housing that engages the cable threads.
3. Push the cable connector into the housing and screw the housing on until the plastic is flush with the metal.

3.0 CONDUCTIVITY

Conductivity Calibration	3.1
Conductivity Care and Maintenance	3.2
Conductivity Storage	3.3
Conductivity Specifications	3.4

3.1 CONDUCTIVITY CALIBRATION

Before performing the following steps, please follow all company, local, state, or national laws and/or regulations regarding proper safety precautions in handling liquids with respect to protective goggles, gloves, or clothing and proximity to eye washes, etc.

Metal housing must be submersed for accurate reading.

Reading is considered stable after change of less than 0.1 mA per minute is observed. It is common that measurement devices do not have greater than 0.01 mA resolution, so the reading may change back and forth (example: 12.07-12.08 mA over and over).

Clear-coated shield wire should be connected when possible for highest accuracy.

Materials required

- STs Series Conductivity Sensor
- PLC, datalogger, RTU, or digital voltmeter with ammeter capabilities
- 0 μ Siemens calibration standard (distilled water)
- Secondary calibration standard (Various solutions-700 μ S, 1000 μ S etc. Conductivity Standard should be above expected sample solution conductivity for most accurate results)

Procedure

Wiring Set-up

Connect the STs Conductivity Sensor to your analog input device (Datalogger, PLC, etc.). Another method is using a digital voltmeter (DVM) with ammeter capabilities connected in series with the pHionics device and an 8-24V power supply.

pHionics Calibration Wiring Examples

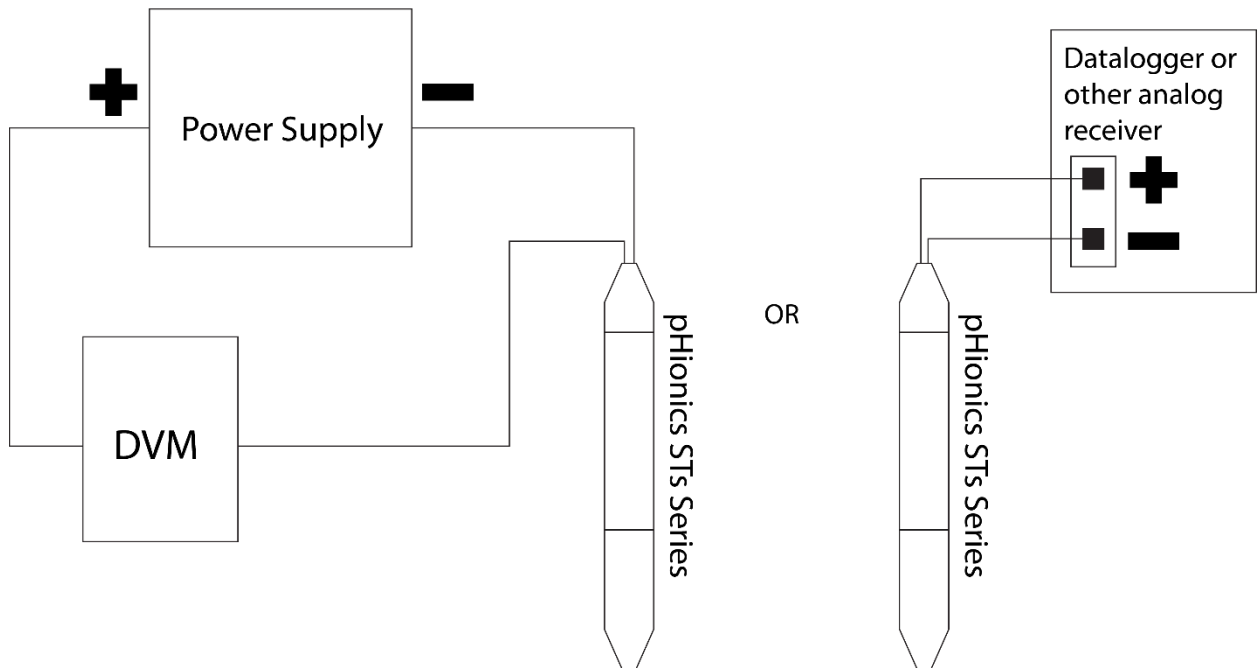

Calibration

1. Submerge sensor in distilled water so that metal housing contacts the solution
2. Swirl sensor around until reading is stabilized.
3. Record the mA output for 0 μ S if reading is between 3.80 and 4.20 mA.
 - a. If reading is not within noted range, repeat the above steps using fresh distilled water. If that does not correct it, then follow the cleaning procedures in Section
4. Submerge the device in the secondary calibration buffer and stir.
5. Wait for the reading to stabilize before recording the mA output.
6. Rinse the electrode with distilled water and use in your application.
7. If readings remain slow or other issues occur, *please* reach out to us at support@phionics.com so we can help.

After the sensor is put into service, the electronics will prove to be very stable, but a recalibration schedule must be determined empirically for each application. For more information on calibration theory and procedures, please reference our article titled [When to Calibrate and Replace an Electrode](#).

If there are problems calibrating the sensor:

Confirm that the problems are not related to the system to which the unit is being interfaced by simulating the input as called out in the operator manuals that are supplied with your respective hardware and/or software. If problems persist, call us at **1-775-339-0565** or email **support@phionic.com**.

3.2 CONDUCTIVITY CARE AND MAINTENANCE

Mechanical Cleaning

pHionics conductivity electrodes are robust and will not be damaged by mechanical means of cleaning such as brushing.

1. Add a detergent such as a hand dish soap to water and dip a soft-bristle brush in the solution.
 - a. Fine wet sandpaper or fine steel wool may also be used.
2. Scrub the electrode vigorously until no signs of contaminant remain. Focus on the four round cells on the electrode and use a brush to clean the inside of the electrode guard. Make sure the plastic along the flat of the electrode is clear of debris to prevent entrapment of air bubbles that would affect measurement. If the electrode still does not appear clean, see the chart below for additional steps.
3. Recalibrate the sensor and verify that the offset is within the acceptable $\pm 15\%$.

Cleaning Procedures

Conductivity and ORP Electrode Cleaning			
Purpose	Symptoms	Cleaning Solutions	Instructions
General Cleaning	Slow response time, inaccurate slope during calibration, inaccurate readings, or drifting	0.1M HCl OR 1:10 bleach dilution with 0.5% detergent solution	Rinse with distilled water after each use. Place probe in cleaning solution for up to 20 mins, checking every 5-10 if symptoms still occur, then rinse with distilled water
Fats, oils, and grease removal	Build-up of lipids on electrode Slow response time, inaccurate slope during calibration, inaccurate readings, or drifting	Mild detergent OR methanol	Soak in 50-60C solution from 1hr to overnight. Rinse with distilled water then soak in 0.1M HCl for 10 mins before recalibrating
Protein removal	Slow response time, inaccurate slope during calibration, inaccurate readings, or drifting	1% pepsin solution with 0.1M HCl OR 0.4M HCl OR contact lens enzymatic cleaner	Immerse in pepsin solution for 5 mins before rinsing with distilled water. OR soak in 0.4M HCl for 10 mins before rinsing with distilled water
Scale/mineral deposit removal	Visible crystalline deposits on electrode	0.1M HCl	Soak in solution for 5 mins or less until deposits are removed then rinse with distilled water

Recalibrate after following the instructions and check that the offset is within range.

Next Steps

Hopefully, the electrode is now as good as new! If, however, none of these steps lead to proper functioning of the electrode then the electrode has reached the end of its life and must be replaced. If the electrode failed significantly faster than expected, please email us with the details of the application process being measured as we may be able to recommend alternate solutions or provide advice on extending electrode life in the future. You deserve the best and we will provide that.

3.3 CONDUCTIVITY STORAGE

Rinse the unit in distilled or clean water prior to storage. Store dry with the electrode guard over the electrode and covered by the provided boot to prevent corrosion due to damp environments. While this may seem ironic, considering the sensor is meant to be in water, air at the surface significantly increases the rate of corrosion in a damp environment.

3.4 CONDUCTIVITY SPECIFICATIONS

2-Wire, 4-20 ma conductivity sensor/transmitters

Output	4 to 20 ma
Power Supply Voltage	8 to 40 VDC
Loop Impedance (Max)	250 ohms at 12 VDC, 800 ohms at 24 VDC
Cable Type	4 Conductor, 24-gauge, twisted pair, 3 mile maximum
Isolation	600 VDC, >70 dB at 50/60 Hz

2-wire, 4-20 ma temperature output

Output	4 to 20 mA
Range	0-50°Celsius
Power Supply Voltage	7 to 40 VDC
Loop Impedance (Max)	250 ohms at 12 VDC, 850 ohms at 24 VDC
Isolation	600 VDC, >70 dB at 50/60 Hz

The following data pertains to all configurations:

Linearity	± 0.2% of Full Scale
Accuracy	± 0.2% of Full Scale
Sensitivity	± 0.05% of Full Scale
Stability	± 0.1% of Full Scale
Repeatability	± 0.1% of Full Scale

Response Time (Including Electrodes)	90% < 5 seconds
Temperature Compensation	2% per degree C
Input Range	0-100, 200, 500, 1000, 2000, 5000, 10,000, 20,000, 50,000, and 100,000 uSiemens * see below
Conductivity Sensing Range	Same as input range above
Pressure	0-70 PSI
Humidity	0-100%
Wetted Materials	316 SS, PVDF, Viton
Length	368 mm (14.5 in.)
Diameter	19 mm (0.750 in.) Maximum
Standard Cable Length	7.6 meters (25 feet)
Shipping Weight (Excluding Cable)	< 0.23 kg (0.5 lb.)

*

0-100 uS	STs 4102 (1.0×10^2)
0-200 uS	STs 4202 (2.0×10^2)
0-500 uS	STs 4502 (5.0×10^2)
0-1,000 uS	STs 4103 (1.0×10^3)
0-2,000 uS	STs 4203 (2.0×10^3)
0-5,000 uS	STs 4503 (5.0×10^3)
0-10,000 uS	STs 4104 (1.0×10^4)
0-20,000 uS	STs 4204 (2.0×10^4)
0-50,000 uS	STs 4504 (2.0×10^4)
0-100,000 uS	STs 4105 (1.0×10^5)
0-specify uS	Replace 4xxx with appropriate numbers -- see exam *

* To determine your custom range, observe the following examples or contact pHionics at the numbers listed below:

Desired Range	Decimal Notation	Model Number
0-250 uS	2.5×10^2	STs 4252
0-2,500 uS	2.5×10^3	STs 4253
0-300 uS	3.0×10^2	STs 4302
0-3,000 uS	3.0×10^3	STs 4303

4.0 DISSOLVED OXYGEN

Dissolved Oxygen Calibration	4.1
Dissolved Oxygen Care and Maintenance	4.2
Dissolved Oxygen Storage	4.3
Dissolved Oxygen Specifications	4.4

4.1 DISSOLVED OXYGEN CALIBRATION

Follow all local laws and regulations regarding proper handling and disposal of the chemicals used during calibration.

Metal housing must be submersed for accurate reading.

Reading is considered stable after change of less than 0.1 mA per minute is observed. It is common that measurement devices do not have greater than 0.01 mA resolution, so the reading may change back and forth (example: 12.07-12.08 mA over and over).

Clear-coated shield wire should be connected when possible for highest accuracy.

Procedure

Wiring Set-up

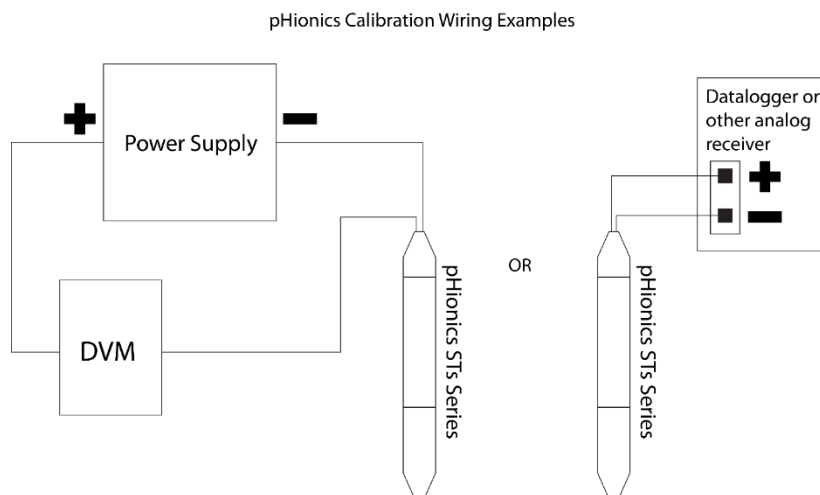

Connect the pHionics STs Dissolved Oxygen device to your analog input device (Datalogger, PLC, etc.). Another method is using a digital voltmeter (DVM) with ammeter capabilities connected in series with the pHionics device and an 8-24V power supply.

TEMP	Elevation (Feet above sea level)						
	0	1000	2000	3000	4000	5000	6000
°C							
0	14.6 mg/L	14.1	13.6	13.2	12.7	12.3	11.8
2	13.8	13.3	12.9	12.4	12.0	11.6	11.2
4	13.1	12.7	12.2	11.9	11.4	11.0	10.6
6	12.4	12.0	11.6	11.2	10.8	10.4	10.1
8	11.8	11.4	11.0	10.6	10.3	9.9	9.6
10	11.3	10.9	10.5	10.2	9.8	9.5	9.2
12	10.8	10.4	10.1	9.7	9.4	9.1	8.8
14	10.3	9.9	9.6	9.3	9.0	8.7	8.3
16	9.9	9.7	9.2	8.9	8.6	8.3	8.0
18	9.5	9.2	8.7	8.6	8.3	8.0	7.7
20	9.1	8.8	8.5	8.2	7.9	7.7	7.4
22	8.7	8.4	8.1	7.8	7.7	7.3	7.1
24	8.4	8.1	7.8	7.6	7.3	7.1	6.8
26	8.1	7.8	7.6	7.3	7.0	6.8	6.6
28	7.8	7.5	7.3	7.0	6.8	6.6	6.3
30	7.5	7.2	7.0	6.8	6.5	6.3	6.1 mg/L

Calibration

- 1) Remove the protective boot from the end of the sensor and rinse the pHionics STs device off with deionized water.
- 2) Fill a container $\frac{3}{4}$ full (must be high enough to submerge the electrode and half the metal housing) with deionized water or any clean water with less than 500 μ s/cm conductivity.
- 3) Let water and sensor reach equilibrium temperature with air.
- 4) Shake container with water vigorously for 30s to reach 100% air-saturated water. Alternately, if you have a large volume of water, then place an air stone in the container and allow the liquid to become saturated over 10-20 minutes.
- 5) Submerge sensor at least halfway and stir the solution.
 - a) The electrode slowly consumes oxygen so water flow is required to avoid artificially low readings.
- 6) Wait until readings stabilize.
- 7) Record mA output and determine the mg/L from what 100% saturation is for the calibration environment based on pressure and temperature using the table above. (e.g. 8.7 mg/L at 22°C and 0 ft. elevation)
- 8) To obtain the calibration slope, subtract 4 mA from the recorded mA output, then divide this number by the mg/L obtained in Step 7.
 - a) If using an RTU or datalogger with scaling, simply input 4 mA for 0 mg/L or 0% saturation and the recorded mA output for the mg/L obtained in Step 7, or for 100% saturation.

Dissolved oxygen sensors generally have a stable and accurate zero at 4 mA so a two-point calibration is not required. If desired, however, then a second calibration point can be measured using one of the following procedures:

Either:

- 1) Aerate deionized water with nitrogen while the sensor is submersed until the output reads $4.00\text{mA} \pm 0.60\text{mA}$ (Approx. 10-20 mins).
- 2) Check electrode tip for remaining air bubbles after submersion and shake to remove if bubbles are present.
- 3) After the reading stabilizes then record the mA value and set it as 0% in the datalogger, PLC, or another data-capturing device.

Or:

- 1) For 0% calibration in the field:
- 2) Mix 3-4g of sodium sulfite (Na_2SO_3) with 100mL of distilled water and stir for approximately 15-20 minutes.
 - a) Cobalt chloride (approx. 1mg) can be added to catalyze the reaction between oxygen and sodium sulfite.
- 3) Submerge sensor up to the metal housing and continue stirring until the reading reaches approximately $4.00\text{mA} \pm 0.20\text{mA}$ and record the value as 0% in the software being used.

Calibration is now complete. Follow this procedure anytime calibration is required.

After the sensor is put into service, the electronics will prove to be very stable, but a recalibration schedule must be determined empirically for each application.

If there are problems calibrating the sensor:

Confirm that the problems are not related to the system to which the unit is being interfaced by simulating the input as called out in the operator manuals that are supplied with your respective hardware and/or software. If problems persist, call us at **1-775-339-0565**.

4.2 DISSOLVED OXYGEN CARE AND MAINTENANCE

Do not attempt to clean the electrode tip through any mechanical means – it **will** tear the membrane.

Be very careful when inserting the electrode through the electrode body and spring – any tear or hole will render the sensor inoperable.

Cleaning Procedures

pH and Dissolved Oxygen Electrode Cleaning			
Purpose	Symptoms	Cleaning Solutions	Instructions
General Cleaning	Slow response time, inaccurate slope during calibration, inaccurate readings, or drifting	0.1M HCl OR 1:10 bleach dilution with 0.5% detergent solution	Rinse with distilled water after each use. Place probe in cleaning solution for up to 20 mins, checking every 5-10 if symptoms still occur, then rinse with distilled water
Rehydration (pH only)	Dry bulb, unstable pH readings, required any time after storage for more than a few months	3M KCl OR pH 4 buffer	Soak in solution from 1hr to overnight until readings stabilize
Fats, oils, and grease removal	Build-up of lipids on electrode Slow response time, inaccurate slope during calibration, inaccurate readings, or drifting	Mild detergent OR methanol	Soak in 50-60C solution from 1hr to overnight. Rinse with distilled water then soak in 0.1M HCl for 10 mins before recalibrating
Protein removal	Slow response time, inaccurate slope during calibration, inaccurate readings, or drifting	1% pepsin solution with 0.1M HCl OR 0.4M HCl OR contact lens enzymatic cleaner	Immerse in pepsin solution for 5 mins before rinsing with distilled water. OR soak in 0.4M HCl for 10 mins before rinsing with distilled water
Scale/mineral deposit removal	Visible crystalline deposits on electrode	0.1M HCl	Soak in solution for 5 mins or less until deposits are removed then rinse with distilled water
Silver precipitate Removal (pH electrode only)	Visible dark deposits in electrode or around junction which occurs in samples containing compounds reactive with silver	1M thiourea in 0.1M HCl	Soak in solution until deposits are removed then rinse with distilled water
Air bubble removal	Trapped air in electrode bulb	None	Hold sensor tightly at opposite end from electrode bulb and shake/flick to push filled solution down into bulb

Mechanical Cleaning

Do not use mechanical methods such as brushes on the electrodes except as a last resort on the dissolved oxygen electrode tip. Even soft brushes may result in damage and cause inaccurate readings.

4.4 DISSOLVED OXYGEN STORAGE

Rinse the unit in distilled or clean water prior to storage. Store dry. To extend electrode life, twist sensor one full turn out of the housing to disconnect it from the sensor.

4.5 DISSOLVED OXYGEN SPECIFICATIONS

2-Wire, 4-20 ma Dissolved Oxygen Sensor

Output	4 to 20 mA
Power Supply Voltage	8 to 40 VDC
Loop Impedance (Max)	200 ohms at 12 VDC, 800 ohms at 24 VDC
Cable Type	4 Conductor, 24-gauge, twisted pair, 3 mile maximum
Isolation	600 VDC, >70 dB at 50/60 Hz

2-Wire, 4-20 ma Temperature Output

Output	4 to 20 mA
Range	0-50°Celsius
Power Supply Voltage	7 to 40 VDC
Loop Impedance (Max)	250 ohms at 12 VDC, 850 ohms at 24 VDC
Isolation	600 VDC, >70 dB at 50/60 Hz

The following data pertains to all configurations:

Linearity	± 0.5% of Full Scale
Accuracy	± 2.0% of Full Scale
Sensitivity	± 0.05% of Full Scale
Stability	± 2.0% of Full Scale
Repeatability	± 1.0% of Full Scale
Response Time (Including Electrodes)	98% < 60 seconds
Temperature Compensation	Yes
Input Range	0-20 ppm (mg/L)
Pressure	0-70 PSI
Humidity	0-100%
Wetted Materials	316 SS, PVDF, Viton, epoxy, Teflon
Length	362 mm (14.25 in.)
Diameter	19 mm (0.750 in.) Maximum
Standard Cable Length	7.62 meters (25 feet)
Shipping Weight (Excluding Cable)	0.227 kg (0.5 lb.)

5.0 ORP

ORP Calibration	5.1
ORP Care and Maintenance	5.2
ORP Storage	5.3
ORP Specifications	5.5

5.1 ORP CALIBRATION

Follow all local laws and regulations regarding proper handling and disposal of the chemicals used during calibration.

Metal housing must be submersed for accurate reading.

Reading is considered stable after change of less than 0.1 mA per minute is observed. It is common that measurement devices do not have greater than 0.01 mA resolution, so the reading may change back and forth (example: 12.07-12.08 mA over and over). ORP calibration solutions are notoriously unstable and may experience greater change.

Clear-coated shield wire should be connected when possible for highest accuracy.

Equipment

- STs Series ORP Sensor
- Freshly prepared ORP calibration buffers (271mV, 475mV, etc.)
 - They must be freshly prepared as ORP is unstable and can change rapidly.
 - Buffers must be allowed to equilibrate to room temperature for highest accuracy
- Device for measuring mA output (Digital voltmeter, programmable logic controller, distributed control system, etc.)

Wiring Set-up

Connect the STs ORP Sensor to your analog input device (Datalogger, PLC, etc.). Another method is using a digital voltmeter (DVM) with ammeter capabilities connected in series with the pHionics device and an 8-24V power supply.

pHionics Calibration Wiring Examples

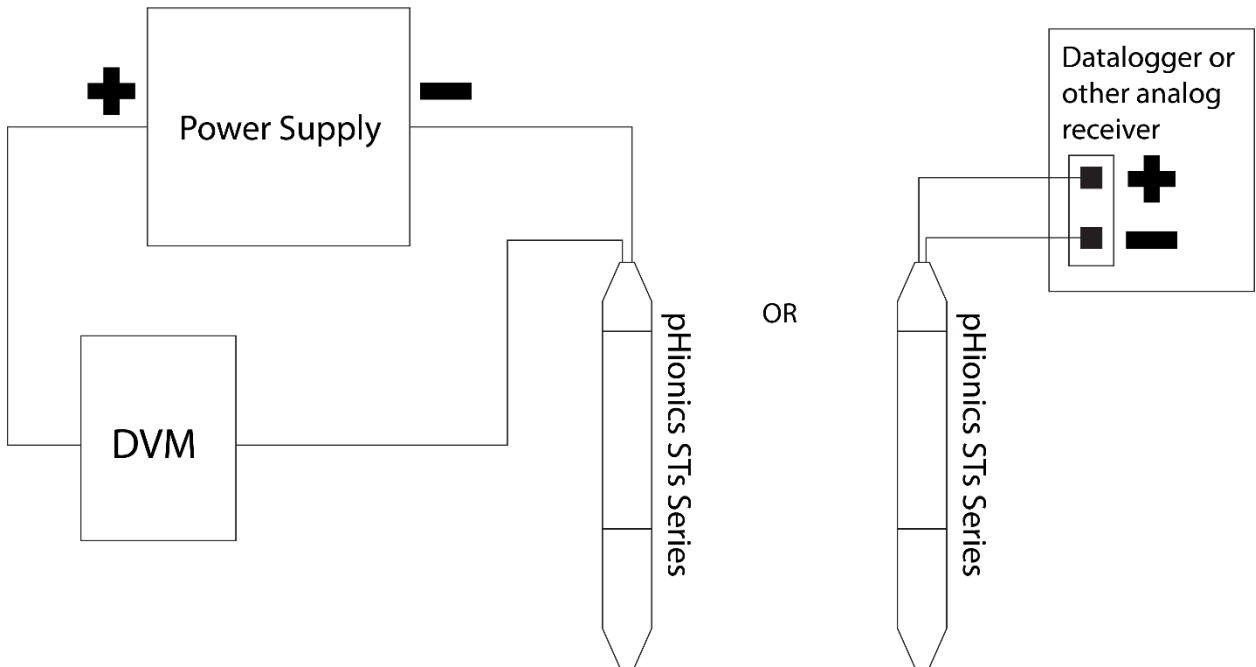

Procedure

1. Rinse electrode with distilled water.
2. Immerse sensor in the first calibration buffer and wait for mA output to stabilize.
3. Record the mA output for the given ORP value in the scaling software of your RTU or datalogger.
4. Rinse the electrode.
5. If using a second buffer, repeat steps 3-5.
6. The pHionics sensor is ready for use.
7. Always keep electrode tip in saturated potassium chloride solution when not in use to preserve reference solution.

Calibration is now complete. Follow this procedure anytime calibration of the sensor is required.

After the sensor is put into service, the electronics will prove to be very stable, but a recalibration schedule must be determined empirically for each application.

If there are problems calibrating the sensor:

Confirm that the problems are not related to the system to which the unit is being interfaced by simulating the input as called out in the operator manuals that are supplied with your respective hardware and/or software. If problems persist, call us at **1-775-339-0565**.

5.2 ORP CARE AND MAINTENANCE

See section 3.2 for ORP care, as it is the same as conductivity except for storage.

5.3 ORP STORAGE

Always rinse off any debris on electrode and store in a concentrated 3.0M KCl solution to extend electrode life. Do not store in deionized water or similar as this will dramatically reduce electrode life.

5.4 ORP SPECIFICATIONS

2-Wire, 4-20 ma ORP Sensor

Output	4 to 20 mA
Power Supply Voltage	8 to 40 VDC
Loop Impedance (Max)	200 ohms at 12 VDC, 800 ohms at 24 VDC, 1600 ohms at 40 VDC
Cable Type	4-conductor, 24-gauge, twisted pair, 3 mile maximum
Isolation	600 VDC, >70 dB at 50/60 Hz

2-Wire, 4-20 ma Temperature Output

Output	4 to 20 mA
Range	0-50°Celsius
Power Supply Voltage	7 to 40 VDC
Loop Impedance (Max)	250 ohms at 12 VDC, 850 ohms at 24 VDC, 1650 ohms at 40 VDC
Isolation	600 VDC, >70 dB at 50/60 Hz

The following data pertains to all configurations:

Linearity (of Electronics)	± 4 mv
Accuracy	± 4 mv
Sensitivity	± 1 mv
Stability	± 2 mv
Repeatability	± 10 mv
Response Time (Including Electrodes)	95% < 20 seconds
Temperature Compensation	None

Input Range	-1000 to +1000 mv, -500 to +500 mv, 0 to +1000mv
ORP Sensing Range	Same as above
Pressure	0-70 PSI
Humidity	0-100%
Wetted Materials	316 SS, PVDF, Viton, epoxy, glass
Length	362 mm (14.25 in.)
Diameter	19 mm (0.750 in.) Maximum
Standard Cable Length	7.6 meters (approx.. 25 feet)
Shipping Weight (Excluding Cable)	0.227 kg (0.5 lb.)

6.0 PH

pH Calibration	6.1
pH Care and Maintenance	6.2
pH Storage	6.3
pH Specifications	6.4

6.1 PH CALIBRATION

Follow all local laws and regulations regarding proper handling and disposal of the chemicals used during calibration.

Metal housing must be submersed for accurate reading.

Reading is considered stable after change of less than 0.1 mA per minute is observed. It is common that measurement devices do not have greater than 0.01 mA resolution, so the reading may change back and forth (example: 12.07-12.08 mA over and over).

Clear-coated shield wire should be connected when possible for highest accuracy.

Required Equipment

- STs Series pH Sensor
- pH calibration buffer (7 pH and either 4 pH or 10 pH buffer depending on the range of samples being measured)
 - If readings are off from expected values, always start by preparing fresh buffer solution

- Device for measuring mA output (Digital voltmeter, programmable logic controller, distributed control system, etc.)

Procedure

1. Rinse electrode with distilled water.
2. Submerge the sensor in 7 pH buffer and wait for reading to stabilize.
 - a. Reading should be 12 ± 0.60 mA for 7 pH buffer. If it is not, the electrode may require cleaning. Follow the instructions in section 4.2 for proper procedures as they are the same as dissolved oxygen electrodes.
 - b. **Always ensure solution is in contact with the metal housing for proper readings.**
3. Record mA output for 7 pH buffer.
4. Rinse electrode with distilled water.
5. Submerge sensor in secondary calibration buffer and wait for reading to stabilize.
 - a. Reading should be 8.56 ± 0.60 mA for 4 pH and 15.4 ± 0.60 mA for 10 pH buffer.
 - b. 10 pH buffer is known to be unstable and should be prepared fresh.
6. Record mA output for secondary buffer and input to software if using automatic scaling.
7. Rinse electrode with distilled water.
8. The sensor is now ready for sampling.
9. Always keep electrode tip in saturated potassium chloride solution when not in use.

Calibration is now complete. Follow this procedure anytime calibration of the sensor is required.

After the sensor is put into service, the electronics will prove to be very stable, but a recalibration schedule must be determined empirically for each application.

If there are problems calibrating the sensor:

Confirm that the problems are not related to the system to which the unit is being interfaced by simulating the input as called out in the operator manuals that are supplied with your respective hardware and/or software. If problems persist, call your local representative or **pHionics** at **1-775-339-0565**.

6.2 PH CARE AND MAINTENANCE

Regeneration

The following section is for pH ONLY. Contact of hydrofluoric acid to a dissolved oxygen electrode could destroy it.

Regeneration is the term used for bringing an electrode back into working order after being unusable due to desensitization of the glass bulb from drying out or general old age. Old age is difficult to define for an electrode because the degradation rate depends entirely on how harsh

the solution being sampled is and can range from 6 months to 10 years or more. The regeneration theory is based upon removal of the damaged outer surface of the bulb using hydrofluoric acid which will stabilize and speed up readings.

Be very careful in following all recommended safety procedure while handling hydrofluoric acid and consult the MSDS. Eye protection, gloves, and a good lab coat are necessities to provide crucial seconds before any splashed or spilled acid reaches your skin and starts to burn. Confirm that a hydrofluoric-resistant container (e.g. NOT glass) is being used. Dip the bulb (and only the bulb) into 0.1M hydrofluoric acid for at most two minutes. Rinse the electrode with distilled water and place in pH 7 buffer for 1 hour. Store electrode in electrolyte solution (3M KCl) overnight before calibration.

If all hope is lost – put a drop of dishwashing soap on a soft toothbrush – and brush the bulb and the liquid junction lightly around the bulb and reference for about a minute. Recalibrate the sensor and recalculate the slope and offset. If there is no change, rinse with tap water and scrub once more vigorously. This process has allowed us to revive many old electrodes out in the field but may result in reduced accuracy and is only recommended as a last resort.

6.3 PH SPECIAL CONSIDERATIONS

Always rinse off any debris on electrode and store in a concentrated 3.0M KCl solution to extend electrode life. Do not store in deionized water or similar as this will dramatically reduce electrode life.

6.5 PH SPECIFICATIONS

2-Wire, 4-20 ma pH Sensor

Output	4 to 20 mA
Power Supply Voltage	8 to 40 VDC
Loop Impedance (Max)	200 ohms at 12 VDC, 800 ohms at 24 VDC, 1600 ohms at 40 VDC
Cable Type	4 Conductor, 24-gauge, twisted pair, 3 mile maximum
Isolation	600 VDC, >70 dB at 50/60 Hz

2-Wire, 4-20 ma Temperature Output

Output	4 to 20 mA
Range	0-50°Celsius
Power Supply Voltage	7 to 40 VDC
Loop Impedance (Max)	250 ohms at 12 VDC, 850 ohms at 24 VDC
Isolation	600 VDC, >70 dB at 50/60 Hz

The following data pertains to all configurations:

Linearity	± 0.004 pH
Accuracy	± 0.014 pH
Sensitivity	± 0.01 pH
Stability	± 0.03 pH per year
Repeatability	± 0.01 pH
Response Time (Including Electrodes)	95% < 5 seconds
Temperature Compensation	Automatic, 0-50 ° C
Input Range	0-14 pH
pH Sensing Range	0-14 pH
Pressure	0-70 PSI
Humidity	0-100%
Wetted Materials	316 SS, PVDF, Viton, glass, epoxy
Length	362 mm (14.25 in.)
Diameter	19 mm (0.750 in.) Maximum
Standard Cable Length	7.6 meters (25 feet)
Shipping Weight (Excluding Cable)	0.227 kg (0.5 lb.)

7.0 TEMPERATURE

Temperature Calibration	7.1
Temperature Care	7.2
Temperature Special Considerations	7.3
Temperature Specifications	7.4

7.1 TEMPERATURE CALIBRATION

Temperature will be within 0.5°C without calibration if the sensor is fully submersed in the solution of interest for at least 10 minutes so does not require calibration.

Using the applicable software or interface to scale a PLC, datalogger, or DCS, setting **4.0 ma to = 0.00** (zero) degrees C. Set **20.0 ma = 50** degrees C.

To connect the sensor to an RTU or datalogger for temperature measurement – connect the **WHITE** and **GREEN** wires to the terminals of the device. Wires are reversible so it does not matter which is connected to power or output.

7.2 TEMPERATURE CARE

None required.

7.3 TEMPERATURE SPECIAL CONSIDERATIONS

Sensor must be fully submersed in sample for accurate temperature measurement.

7.4 TEMPERATURE SPECIFICATIONS

2-Wire, 4-20 ma Temperature Output

Output	4 to 20 mA
Range	0-50°Celsius
Response Time	Approx. 1 minute after sensor has equalized with solution
Power Supply Voltage	7 to 40 VDC
Loop Impedance (Max)	250 ohms at 12 VDC, 850 ohms at 24 VDC, 1650 ohms at 40 VDC
Cable Type	4 Conductor, twisted pair, 3 mile maximum
Isolation	600 VDC, >70 dB at 50/60 Hz
Linearity	± 0.15 °C
Accuracy	± 0.5 °C
Sensitivity	± 0.01 °C
Stability	± 0.05 °C per year
Repeatability	± 0.01 °C
Temperature Sensing Type	Semiconductor
Temperature Sensing Range	0-50 °C
Pressure	0-70 PSI
Humidity	0-100%
Wetted Materials	316 SS, PVDF, Viton
Length	362 mm (14.25 in.)
Diameter	19 mm (0.750 in.) Maximum
Standard Cable Length	7.6 meters (25 feet)
Shipping Weight (Excluding Cable)	0.227 kg (0.5 lb.)

The sensor and cable can be submersed in any body of water to approximately 70 psi or mounted in a stilling well along a river to prevent the sensor from being moved by the currents and hitting stray rocks. They can be freely suspended by their Kevlar-reinforced cable, or, permanently mounted in a cooling tower, process tank, or in a manhole of a sewer system. The sensor can be readily mounted in an insertion or submersion manner simply by placing a 3/4" MNPT gland (compression) fitting in the position desired.

For *submersion* applications, the best placement of the gland fitting is between the indents of the sensor with the threads directed toward the *cable end* of the sensor. However, for the best results, the gland should be mounted towards the cable end of the transmitter housing, as this allows for the temperature output and the temperature compensation to achieve the best results.

Tighten the fitting until it firmly grasps the sensor – *do not over-tighten or clamp down upon the O-rings* – potentially damaging the seals. The fitting would then be threaded and sealed into a 3/4" NPT female fitting attached to a section of pipe extending to the length desired for monitoring or controlling a process in a tank or well, for example. The material selected for this should be compatible with the solution in which it is submersed. Inexpensive 3/4" PVC will work quite well for most applications, as shown to the right.

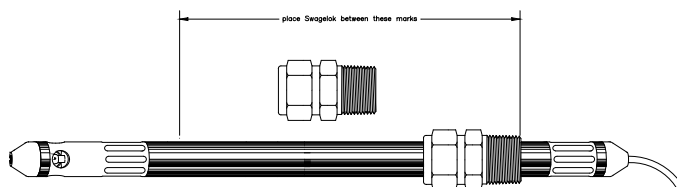

For most parameters (except for conductivity and temperature) the sensor end of the sensor should be angled at least thirty degrees below the cable to prevent air entrapment in the reference solutions or measurement electrode. *Care must*

be taken to assure that the stainless-steel housing is contacting the solution to be measured – or the differential amplifiers will not perform properly – making the measurements appear to be erratic.

In insertion applications, extreme care must be observed when inserting or removing the sensor/transmitter – 100 psi can turn the sensor/transmitter into a lethal projectile – ripping conduit off walls – as well as causing serious injury or death due to trauma or contact with the solution. pHionics is not responsible and does not warrant insertion applications – proceed with extreme caution.

9.0 WARRANTY

pHionics warrants its instruments to be free from defect in material and workmanship under normal use for a period of twenty-four months from date of purchase by the initial owner (the warranty excludes the electrode). Please test the unit before using it in your application. We cannot accept the return of a sensor or sensor after application for reasons other than warranty. Nor do we warrant the sensor or sensor for any specific application. Determination of application compatibility is the sole responsibility of the procurer. pH, ORP, dissolved oxygen, and similar electro-chemical electrodes are not warranted against failure. If the sensor or sensor is stained or disfigured in such a manner as to preclude it from being sold as new -- the unit cannot be accepted as a return and the procurer will remain responsible for any monies owed.

The sensors are tested extensively during manufacturing and cannot be warranted against leaks once they leave the factory due to improper removal and insertion of electrode and cable assemblies.

Warranty does not cover defects caused by abuse or electrical damage. **pHionics** will not cover under warranty any instruments damaged during shipment to the factory improperly packed. Repair attempts by other than authorized service personnel will void warranty.

If within the warranty period, the equipment does not meet the specifications at time of purchase, **pHionics** shall correct any such defect or non-conformance by (at our option) repairing any defective part or parts that are returned to us, or by making available at your facility (via lowest freight rate) a repaired or replacement part, or by crediting your account, if we deem it appropriate.

Items returned for warranty repair must be prepaid and insured for shipment. Warranty claims are processed on the condition that prompt notification of a defect is given to **pHionics** within the warranty period. **pHionics** shall have the sole right to determine if in fact a warranty situation exists.

pHionics' warranty does not cover travel, travel time, mileage, removal, reinstallation, or calibration expenses.

The foregoing warranty is exclusive and in lieu of all other warranties whether written, oral, or implied, and we make *no warranty of merchantability or fitness for a particular purpose*.

Our liability to you arising out of supplying of this equipment or its use whether based on warranty, contract or negligence shall not in any case exceed the cost of correcting defects in the equipment as herein provided and upon the expiration of the applicable warranty period as aforementioned, all such liability shall terminate. The foregoing shall constitute your sole remedy and our sole liability. *In no event shall we be liable for special or consequential damages.*

10.0 RETURN OF MATERIAL

Material returned for repair, whether in or out of warranty (**please read warranty section regarding types of material which cannot be accepted back for environmental and/or safety reasons**), should be shipped prepaid, insured to:

**pHionics Inc.
6680 Alhambra Avenue, #504
Martinez, CA 94553**

RMA No: (call for return of merchandise authorization number -- material cannot be accepted without an RMA number – merchandise returned for credit may be subject to a twenty percent restocking fee – at the discretion of **pHionics**).

The returned material should be accompanied by a letter of transmittal that should include the following:

Subject: Return of Materials for Repair

1. Location, type of service, and length of time in service of device.
2. Description of the faulty operation of the device and the circumstances of the failure.
3. Name, telephone, and FAX number of the person to contact if there are questions regarding the returned material.
4. Statement as to whether warranty or non-warranty service is requested.
5. Complete instructions as to how you would like any problems resolved, etc.
6. Complete shipping instructions for return of the material.

Adherence to these procedures will expedite handling of the returned material and will prevent unnecessary additional charges for inspection and testing to determine the problem with the device. If the material is returned for out of warranty repairs, a purchase order for repairs should be enclosed with the letter of transmittal.

Statement of pHionics product policy

It is a primary objective of **pHionics**, Inc. to provide a product and/or service to our customers of outstanding value, safety, reliability, and quality. In our concern for the world that we share, we will attempt to package and design our products in an environmentally conscious manner.

11.0 PROPER DISPOSAL AT END OF LIFE

To comply with the Waste Electrical and Electronic Equipment Directive in the EU, this product must not be disposed of in unsorted municipal waste. Please check with your EU distributor to find out more about proper disposal of this product.



EU Declaration of Conformity

pHionics Inc.

112 N. Curry, Carson City, NV 89703

United States

Declares that this Declaration of Conformity is issued under our sole responsibility. It belongs to the following product and its configurations:

Product Name: pHionics STs Series™ Conductivity

Serial Number: STs4--- (Configuration suffixes and codes specified on pg. 42)

Description: An electrochemical sensor for measurement of conductivity in aqueous solutions. Includes a built-in transmitter for 4-20 mA signal output.

We declare that the previously described product is in conformity with the essential requirements of the following legislation:

- **Directive 2014/30/EU** of the European Parliament and of the Council of 26 February 2014 on the harmonisation of the laws of the Member States relating to electromagnetic compatibility according to the standards:
 - EN 55011:2016 - Industrial, scientific and medical equipment - Radio-frequency disturbance characteristics - Limits and methods of measurement
 - EN 61326-1:2013 - Electrical equipment for measurement, control and laboratory use - EMC requirements - Part 1: General requirements

- **Directive 2011/65/EU** of the European Parliament and of the Council of 8 June 2011 on the restriction of the use of certain hazardous substances in electrical and electronic equipment (in short referred to as "the RoHS Directive" or "2011/65/EU") according to the standards:
 - IEC 62321 - Electrotechnical products - Determination of levels of six regulated substances (lead, mercury, cadmium, hexavalent chromium, polybrominated biphenyls, polybrominated diphenyl ethers) (this standard has multiple parts.

- **Directive 2012/19/EU** of the European Parliament and of the Council of 4 July 2012 on waste electrical and electronic equipment (WEEE) (in short referred to as "the WEEE Directive" or "2012/19/EU")

Signed by: Gary Brundage, President, pHionics Inc. **Date of Issuance:** February 22 2021

Signature:



pHionics STs Series™ Conductivity

Model	Suffix Codes		Description
STs4	102		Transmitter calibrated to range of 0-100 $\mu\text{S}/\text{cm}$
STs4	202		Transmitter calibrated to range of 0-200 $\mu\text{S}/\text{cm}$
STs4	502		Transmitter calibrated to range of 0-500 $\mu\text{S}/\text{cm}$
STs4	103		Transmitter calibrated to range of 0-1000 $\mu\text{S}/\text{cm}$
STs4	203		Transmitter calibrated to range of 0-2000 $\mu\text{S}/\text{cm}$
STs4	503		Transmitter calibrated to range of 0-5000 $\mu\text{S}/\text{cm}$
STs4	104		Transmitter calibrated to range of 0-10000 $\mu\text{S}/\text{cm}$
STs4	204		Transmitter calibrated to range of 0-20000 $\mu\text{S}/\text{cm}$
STs4	504		Transmitter calibrated to range of 0-50000 $\mu\text{S}/\text{cm}$
STs4	105		Transmitter calibrated to range of 0-100000 $\mu\text{S}/\text{cm}$
STs4	---	s	Transmitter housing made of 316 Stainless Steel
STs4	---	t	Transmitter housing made of titanium

EU Declaration of Conformity

pHionics Inc.

112 N. Curry, Carson City, NV 89703
United States

Declares that this Declaration of Conformity is issued under our sole responsibility. It belongs to the following product and its configurations:

Product Name: pHionics STs Series™ pH

Serial Number: STs1--- (Configuration suffixes and codes specified on pg. 44)

Description: An electrochemical sensor for measurement of pH in aqueous solutions. Includes a built-in transmitter for 4-20 mA signal output.

We declare that the previously described product is in conformity with the essential requirements of the following legislation:

- **Directive 2014/30/EU** of the European Parliament and of the Council of 26 February 2014 on the harmonisation of the laws of the Member States relating to electromagnetic compatibility according to the standards:
 - EN 55011:2016 - Industrial, scientific and medical equipment - Radio-frequency disturbance characteristics - Limits and methods of measurement
 - EN 61326-1:2013 - Electrical equipment for measurement, control and laboratory use - EMC requirements - Part 1: General requirements

- **Directive 2011/65/EU** of the European Parliament and of the Council of 8 June 2011 on the restriction of the use of certain hazardous substances in electrical and electronic equipment (in short referred to as "the RoHS Directive" or "2011/65/EU") according to the standards:
 - IEC 62321 - Electrotechnical products - Determination of levels of six regulated substances (lead, mercury, cadmium, hexavalent chromium, polybrominated biphenyls, polybrominated diphenyl ethers) (this standard has multiple parts.

- **Directive 2012/19/EU** of the European Parliament and of the Council of 4 July 2012 on waste electrical and electronic equipment (WEEE) (in short referred to as "the WEEE Directive" or "2012/19/EU")

Signed by: Gary Brundage, President, pHionics Inc. **Date of Issuance** February 22, 2021

Signature: 

pHionics STs Series™ pH

Model	Suffix Codes		Description
STs1	014		Transmitter calibrated to range of 0-14 pH
STs1	611		Transmitter calibrated to range of 6-11 pH
STS1	---	s	Transmitter housing made of 316 Stainless Steel
STs1	---	t	Transmitter housing made of titanium

EU Declaration of Conformity

pHionics Inc.

112 N. Curry, Carson City, NV 89703

United States

Declares that this Declaration of Conformity is issued under our sole responsibility. It belongs to the following product and its configurations:

Product Name: pHionics STs Series™ Dissolved Oxygen

Serial Number: STs3--- (Configuration suffixes and codes specified on pg. 46)

Description: An electrochemical sensor for measurement of dissolved oxygen in aqueous solutions. Includes a built-in transmitter for 4-20 mA signal output.

We declare that the previously described product is in conformity with the relevant Union harmonization legislation, as follows:

- **Directive 2014/30/EU** of the European Parliament and of the Council of 26 February 2014 on the harmonisation of the laws of the Member States relating to electromagnetic compatibility according to the standards:
 - EN 55011:2016 - Industrial, scientific and medical equipment - Radio-frequency disturbance characteristics - Limits and methods of measurement
 - EN 61326-1:2013 - Electrical equipment for measurement, control and laboratory use - EMC requirements - Part 1: General requirements

- **Directive 2011/65/EU** of the European Parliament and of the Council of 8 June 2011 on the restriction of the use of certain hazardous substances in electrical and electronic equipment (in short referred to as "the RoHS Directive" or "2011/65/EU") according to the standards:
 - IEC 62321 - Electrotechnical products - Determination of levels of six regulated substances (lead, mercury, cadmium, hexavalent chromium, polybrominated biphenyls, polybrominated diphenyl ethers) (this standard has multiple parts.

- **Directive 2012/19/EU** of the European Parliament and of the Council of 4 July 2012 on waste electrical and electronic equipment (WEEE) (in short referred to as "the WEEE Directive" or "2012/19/EU")

Signed by: Gary Brundage, President, pHionics Inc. **Date of Issuance** February 22, 2021

Signature: 

pHionics STs Series™ Dissolved Oxygen

Model	Suffix Codes		Description
STs3	020		Transmitter calibrated to range of 0-14 pH
STs3	---	s	Transmitter housing made of 316 Stainless Steel
STs3	---	t	Transmitter housing made of titanium

EU Declaration of Conformity

pHionics Inc.

112 N. Curry, Carson City, NV 89703

United States

Declares that this Declaration of Conformity is issued under our sole responsibility. It belongs to the following product and its configurations:

Product Name: pHionics STs Series™ ORP (redox)

Serial Number: STs2--- (Configuration suffixes and codes specified on pg. 48)

Description: An electrochemical sensor for measurement of oxidation and reduction potential in aqueous solutions. Includes a built-in transmitter for 4-20 mA signal output.

We declare that the previously described product is in conformity with the essential requirements of the following legislation:

- **Directive 2014/30/EU** of the European Parliament and of the Council of 26 February 2014 on the harmonisation of the laws of the Member States relating to electromagnetic compatibility according to the standards:
 - EN 55011:2016 - Industrial, scientific and medical equipment - Radio-frequency disturbance characteristics - Limits and methods of measurement
 - EN 61326-1:2013 - Electrical equipment for measurement, control and laboratory use - EMC requirements - Part 1: General requirements

- **Directive 2011/65/EU** of the European Parliament and of the Council of 8 June 2011 on the restriction of the use of certain hazardous substances in electrical and electronic equipment (in short referred to as "the RoHS Directive" or "2011/65/EU") according to the standards:
 - IEC 62321 - Electrotechnical products - Determination of levels of six regulated substances (lead, mercury, cadmium, hexavalent chromium, polybrominated biphenyls, polybrominated diphenyl ethers) (this standard has multiple parts.

- **Directive 2012/19/EU** of the European Parliament and of the Council of 4 July 2012 on waste electrical and electronic equipment (WEEE) (in short referred to as "the WEEE Directive" or "2012/19/EU")

Signed by: Gary Brundage, President, pHionics Inc. **Date of Issuance** February 22, 2021

Signature: 

pHionics STs Series™ ORP (redox)

Model	Suffix Codes		Description
STs2	100		Transmitter calibrated to range of 0 to +1000 mV
STs2	505		Transmitter calibrated to range of -500 to +500 mV
STs2	101		Transmitter calibrated to range of -1000 to +1000 mV
STs2	001		Transmitter calibrated to range of -1000 to 0 mV
STs2	---	s	Transmitter housing made of 316 Stainless Steel
STs2	---	t	Transmitter housing made of titanium